

Trabajo final ciclo escolar
2009-2009

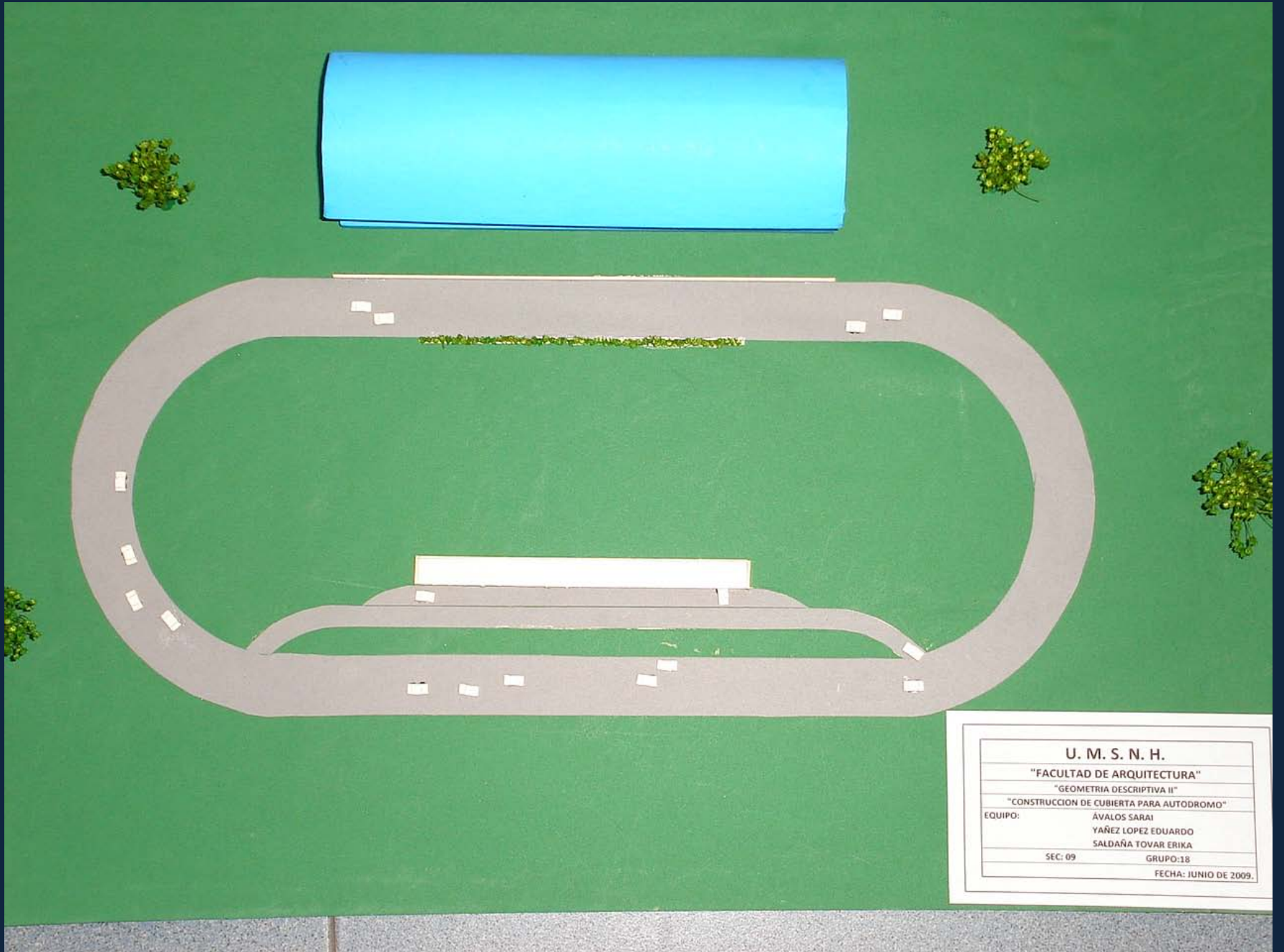

U. M. S. N. H.	
"FACULTAD DE ARQUITECTURA"	
"GEOMETRIA DESCRIPTIVA II"	
"CONSTRUCCION DE CUBIERTA PARA AUTODROMO"	
EQUIPO:	ÁVALOS SARAI YAÑEZ LOPEZ EDUARDO SALDAÑA TOVAR ERIKA
SEC: 09	GRUPO: 18
FECHA: JUNIO DE 2009.	

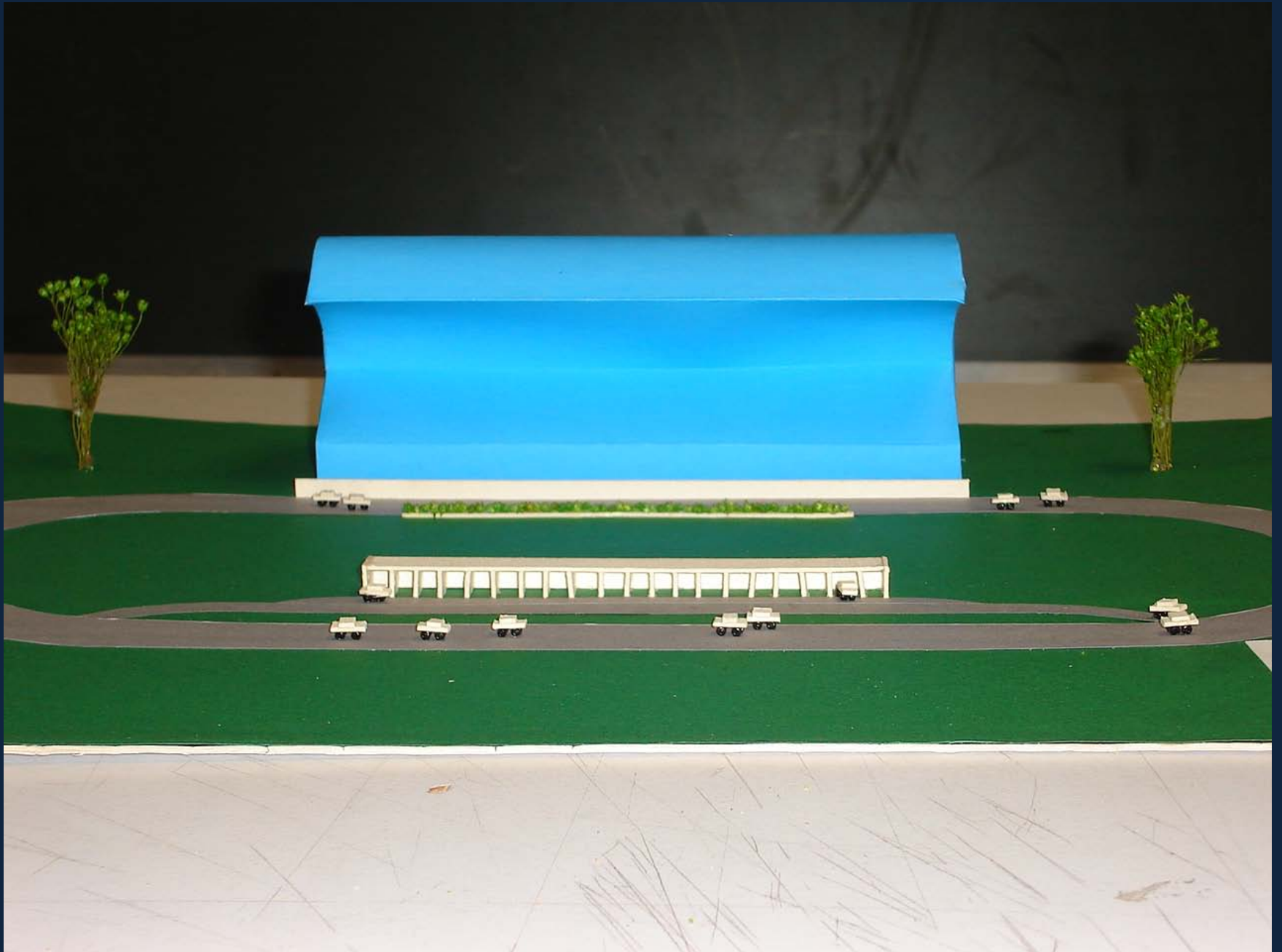

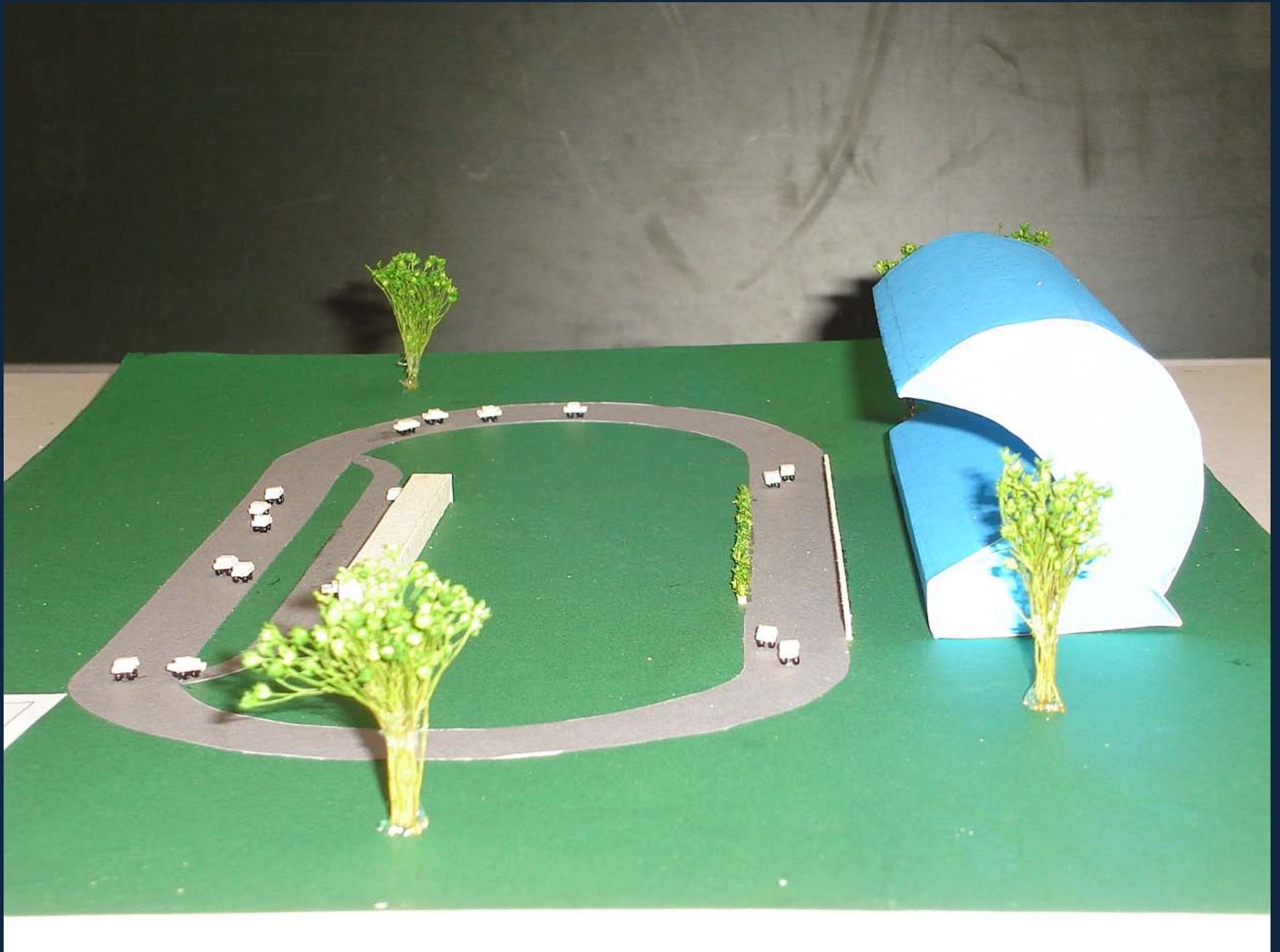

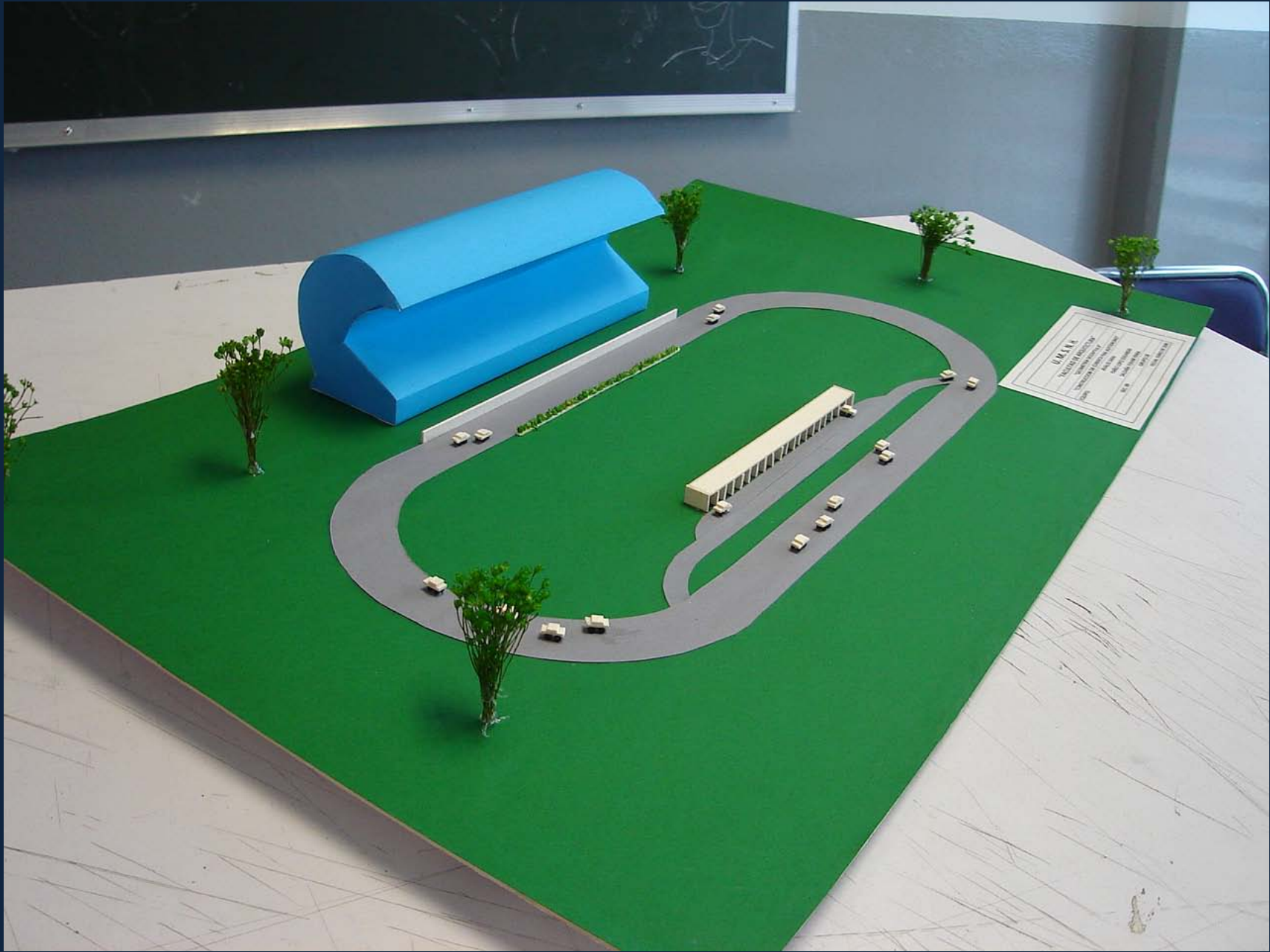

UNIVERSITY OF ...
ARCHITECTURE ...
PROJECT ...
DATE ...
NAME ...

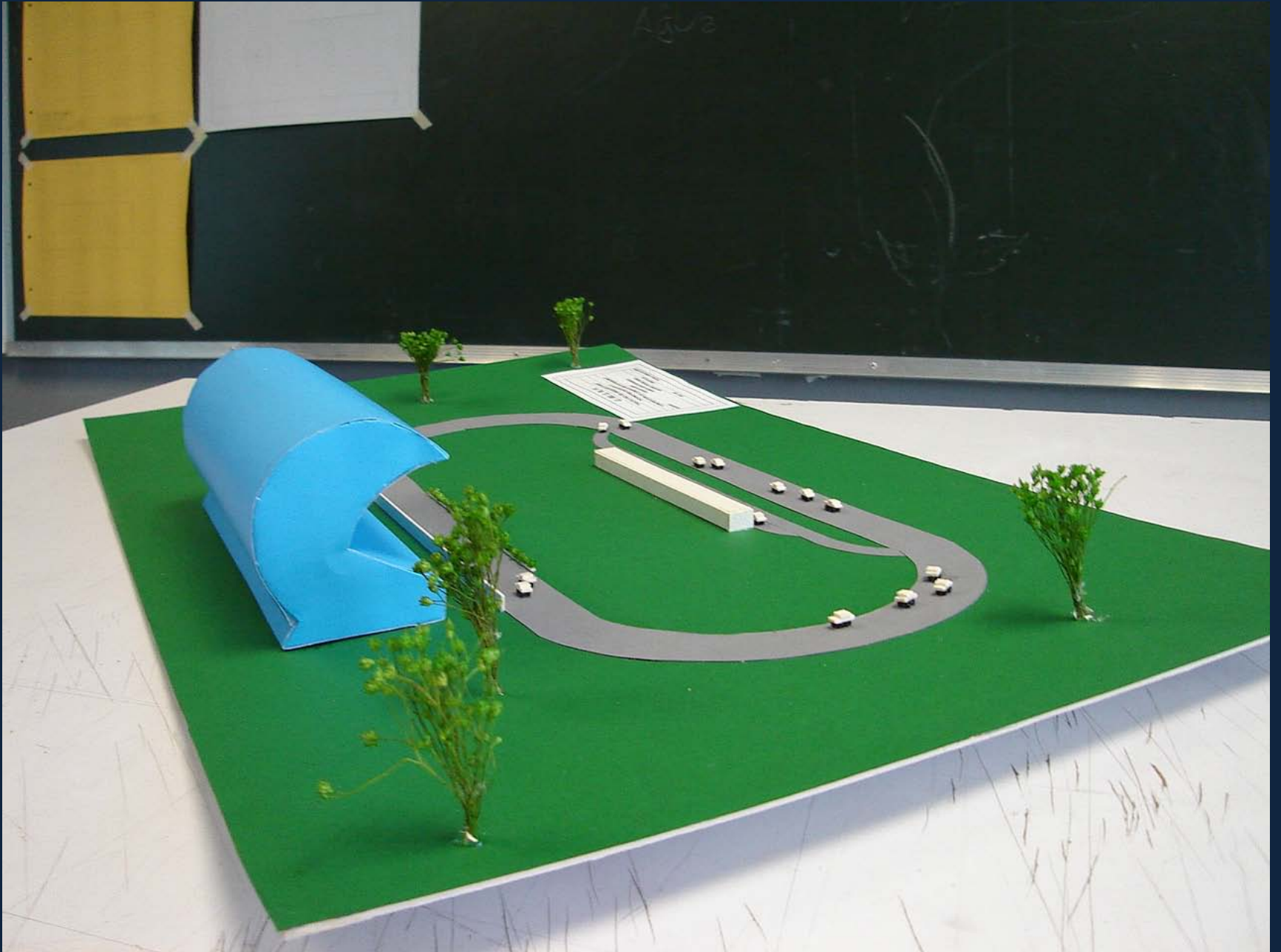

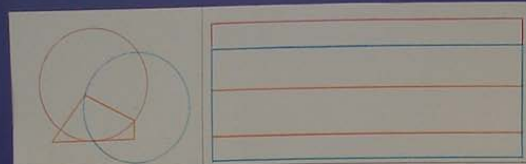

"MONTA COMPOSICIÓN DE VOLÚMENES"

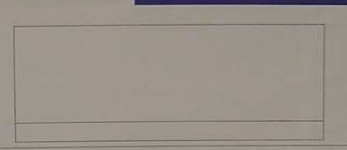
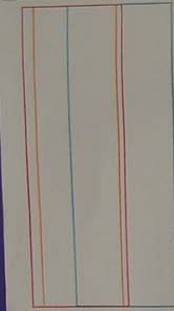

"MONTA INTERSECCIÓN DE VOLÚMENES 1 Y 2"

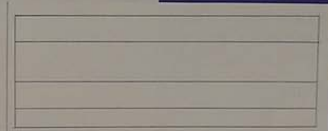

"DESARROLLO DE LAS TAPAS"



"MONTA INTERSECCIÓN DE VOLÚMENES 1, 2 Y 3"

"DESARROLLO DE CUBIERTA INFERIOR"



"DESARROLLO DE BASE Y GRADAS"



U. M. S. N. H.
"FACULTAD DE ARQUITECTURA"
"ESCUELA PROFESIONAL N.º 1"
"CONSTRUCCIÓN DE CUBIERTA PARA AUTOMÓVIL"
EQUIPO:
PABLO LÓPEZ ESCOBAR
SANDRA YONNY RAMA
MAY 20
GRUPO 12
MAYO, AÑO DE 2009

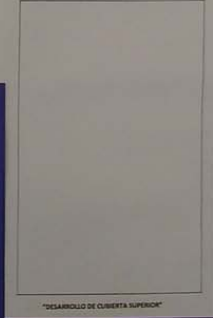

"DESARROLLO DE CUBIERTA SUPERIOR"

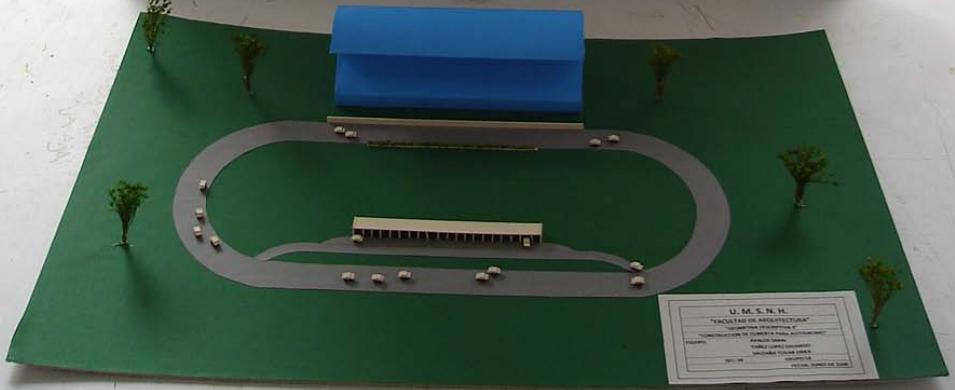
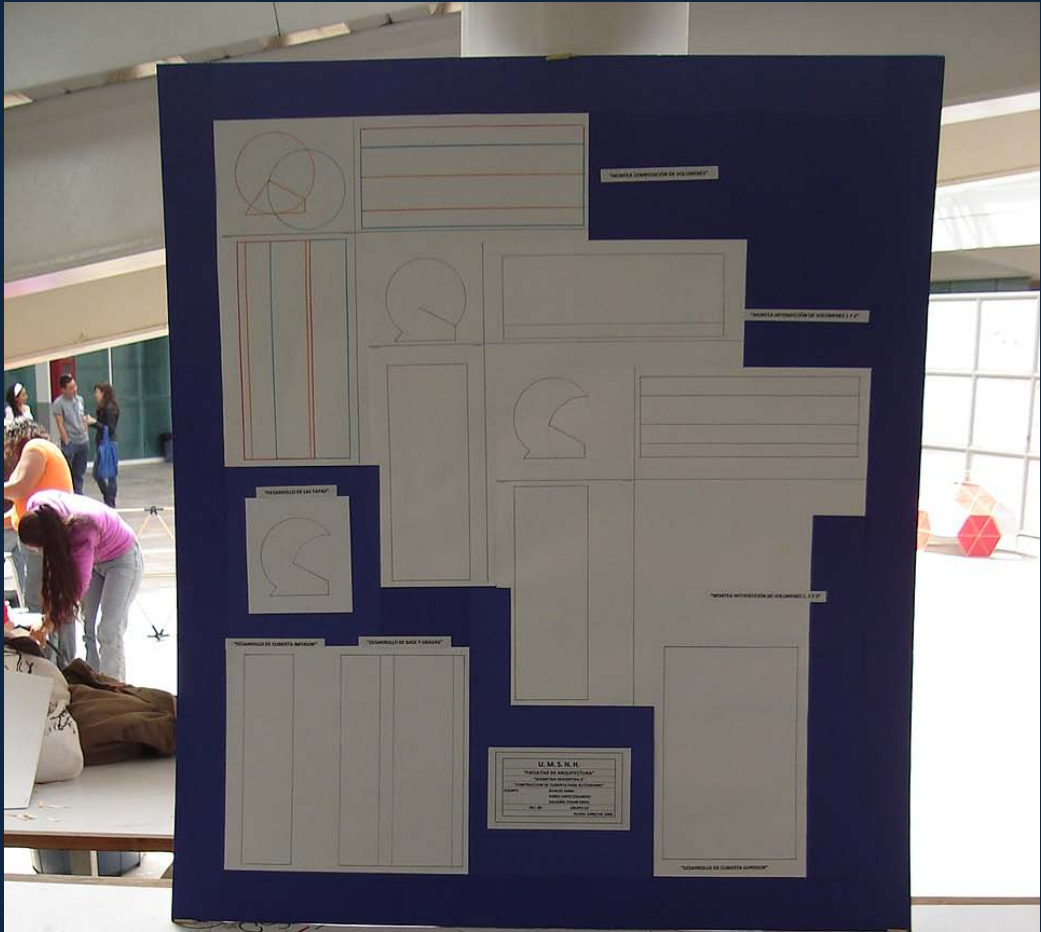

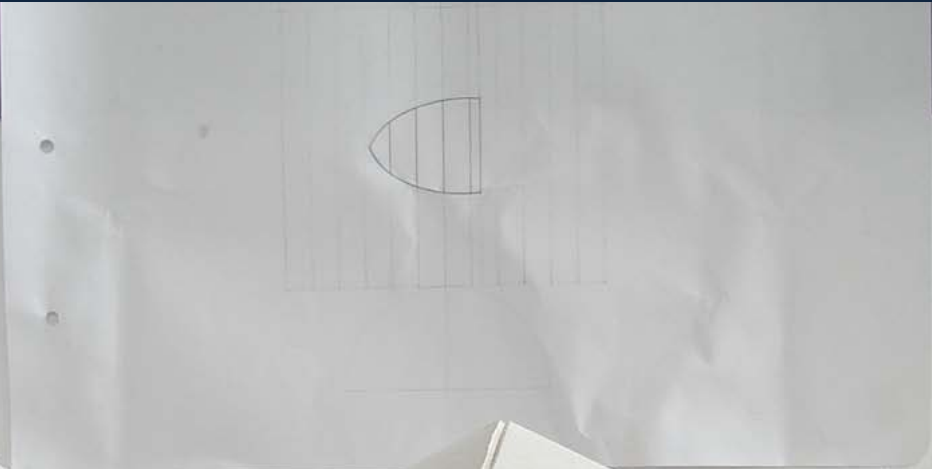
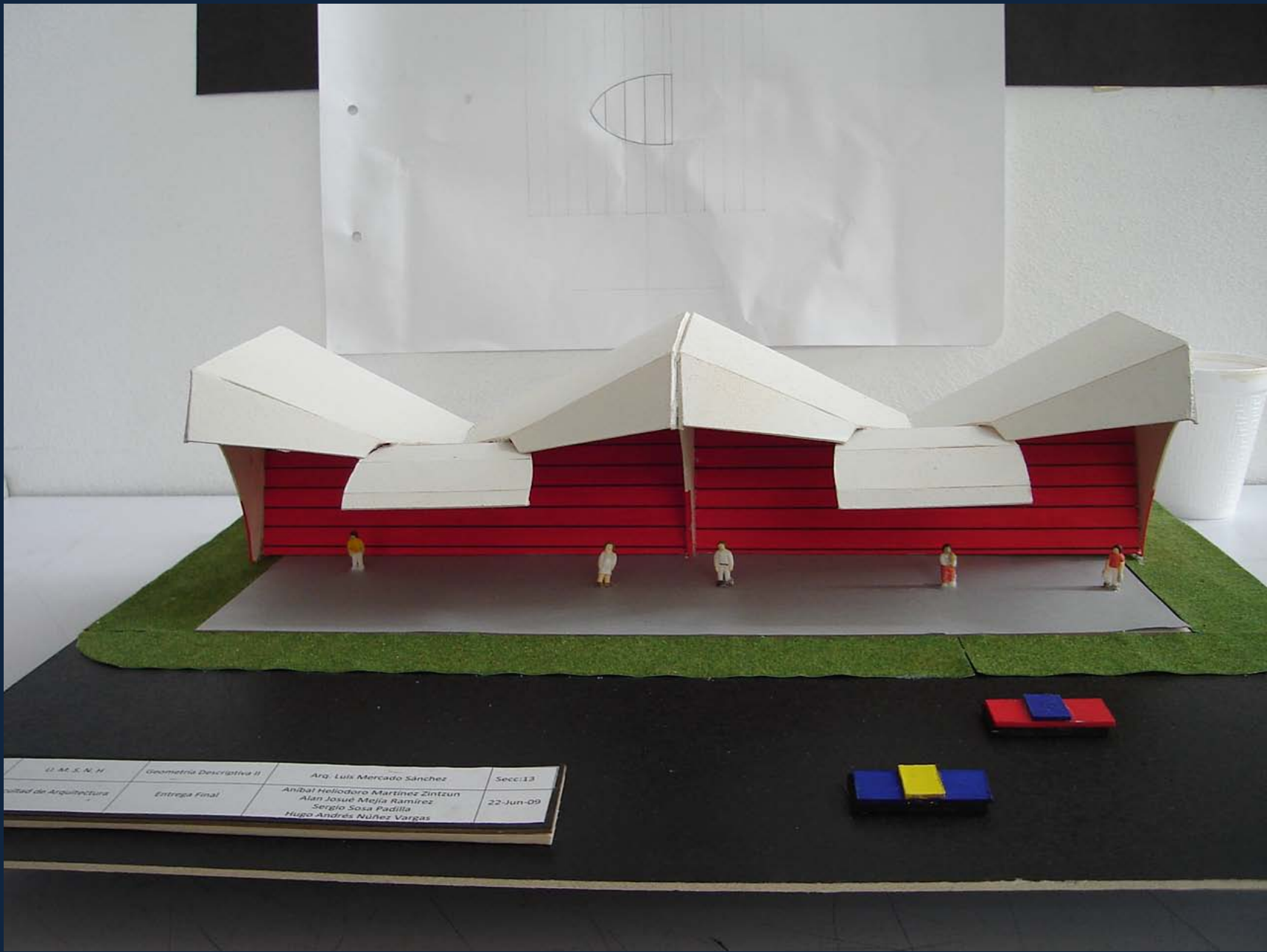

U. A. S. N. H.	Geometría Descriptiva II	Arq. Luis Mercado Sánchez	Secci:13
Escuela de Arquitectura	Entrega Final	Anibal Heliodoro Martínez Zintzun Alan Josue Mejia Ramirez Sergio Soza Padilla Hugo Andrés Núñez Vargas	22-Jun-09





	U. M. S. N. H.	Geometría Descriptiva II	Alfa, Luis Mercado Sánchez	Sécc. 13
			Abel Bal Holochero Martínez Zúñiga	





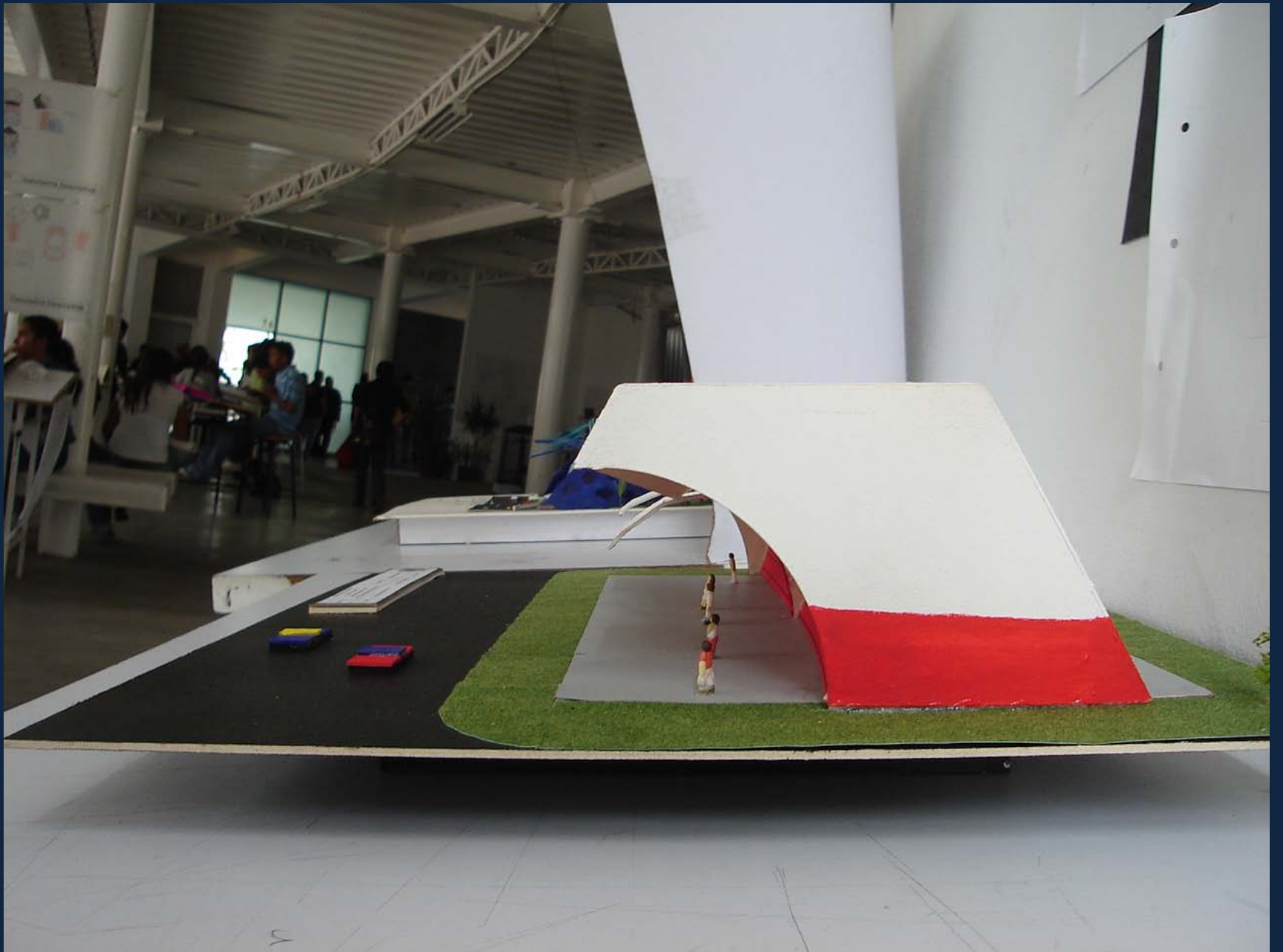

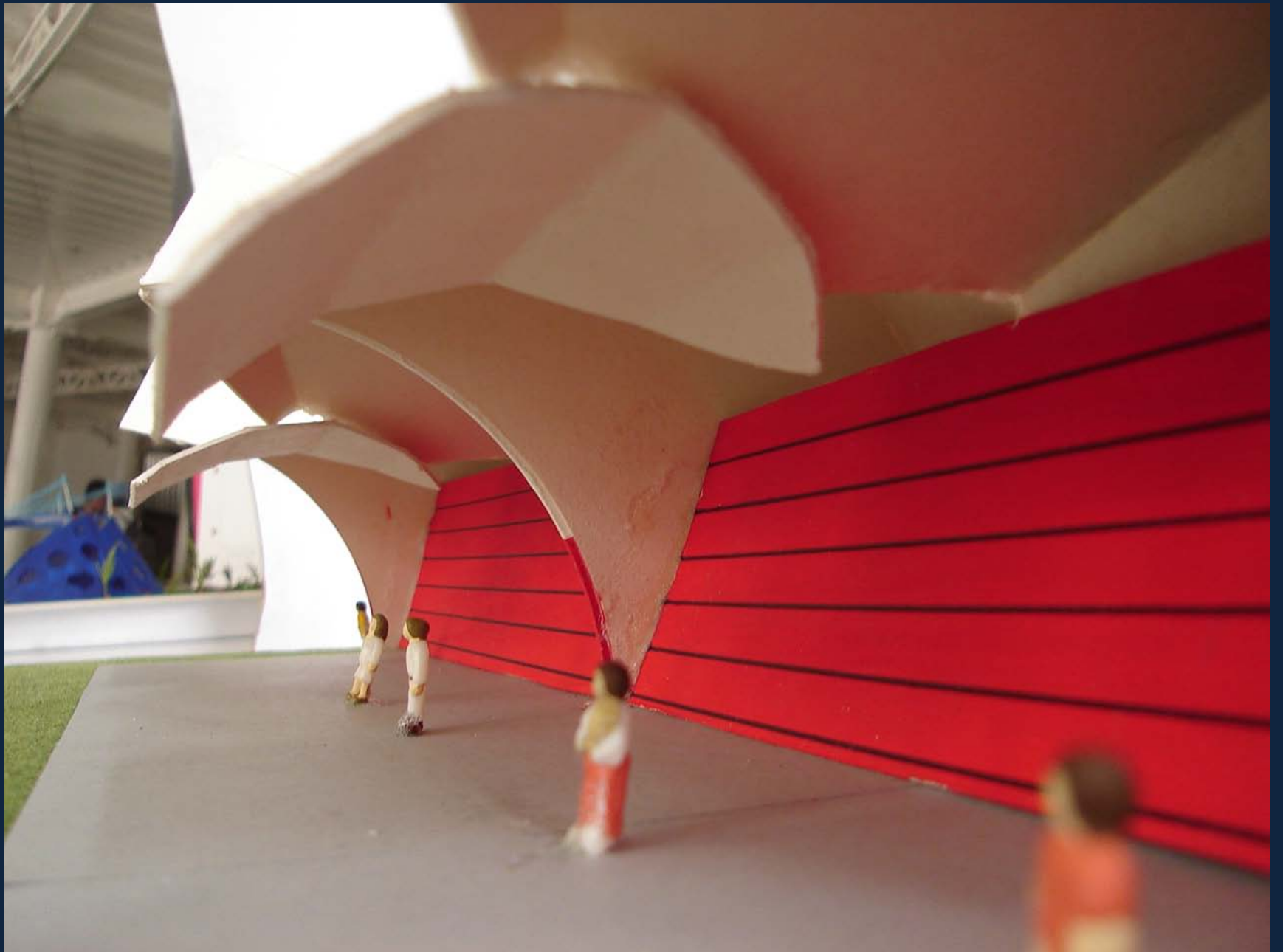

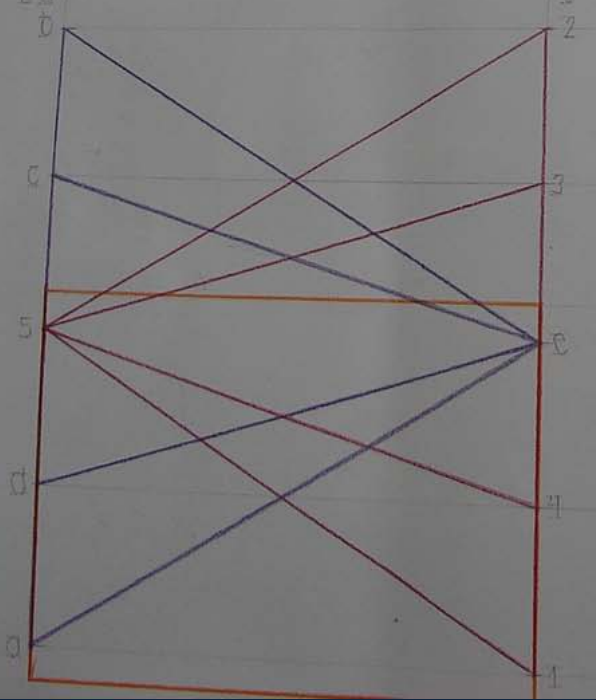
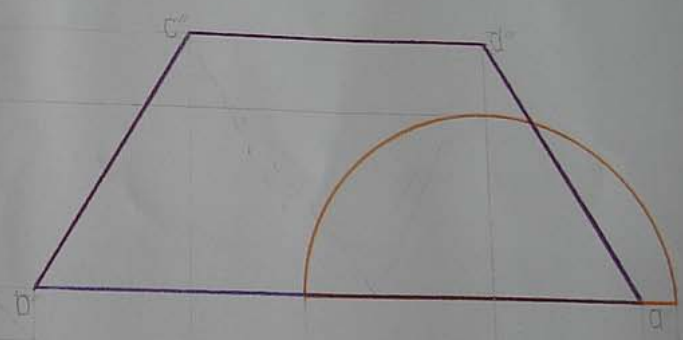
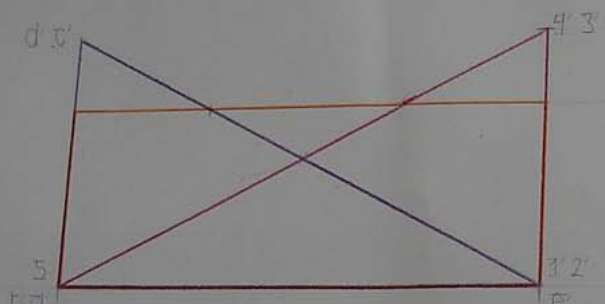

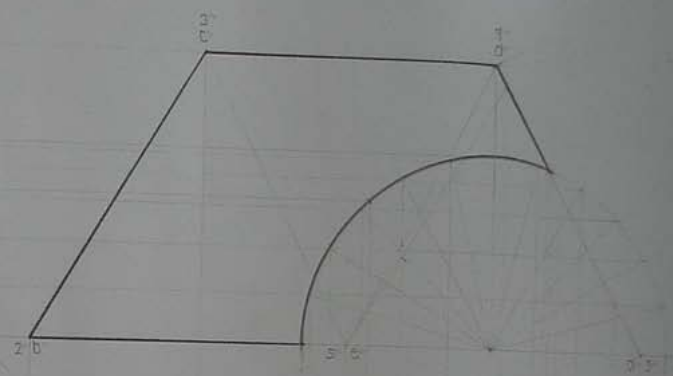
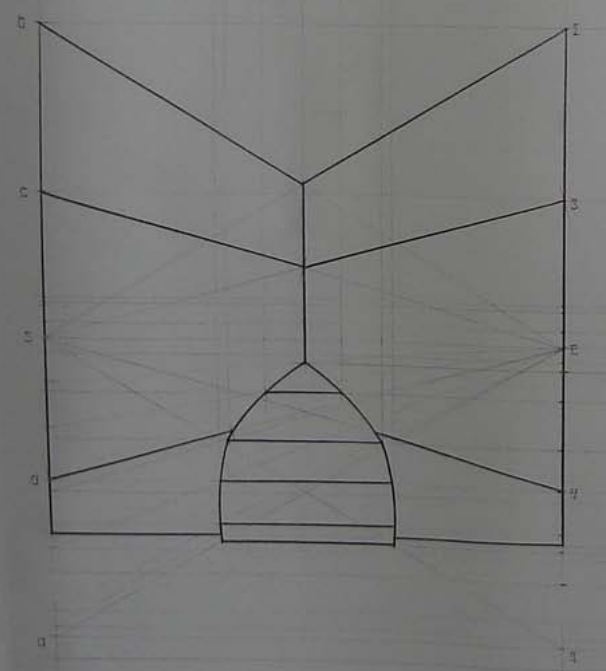
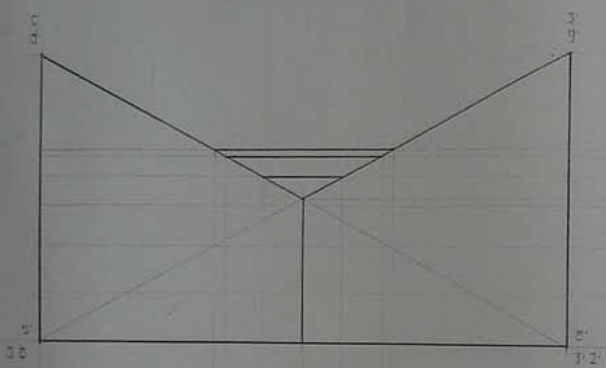



UNIVERSIDAD MICHOACANA DE SAN NICOLÁS DE HIDALGO
FACULTAD DE ARQUITECTURA
GEOMETRÍA DESCRIPTIVA II
AEC. LUIS MERCADO SÁNCHEZ





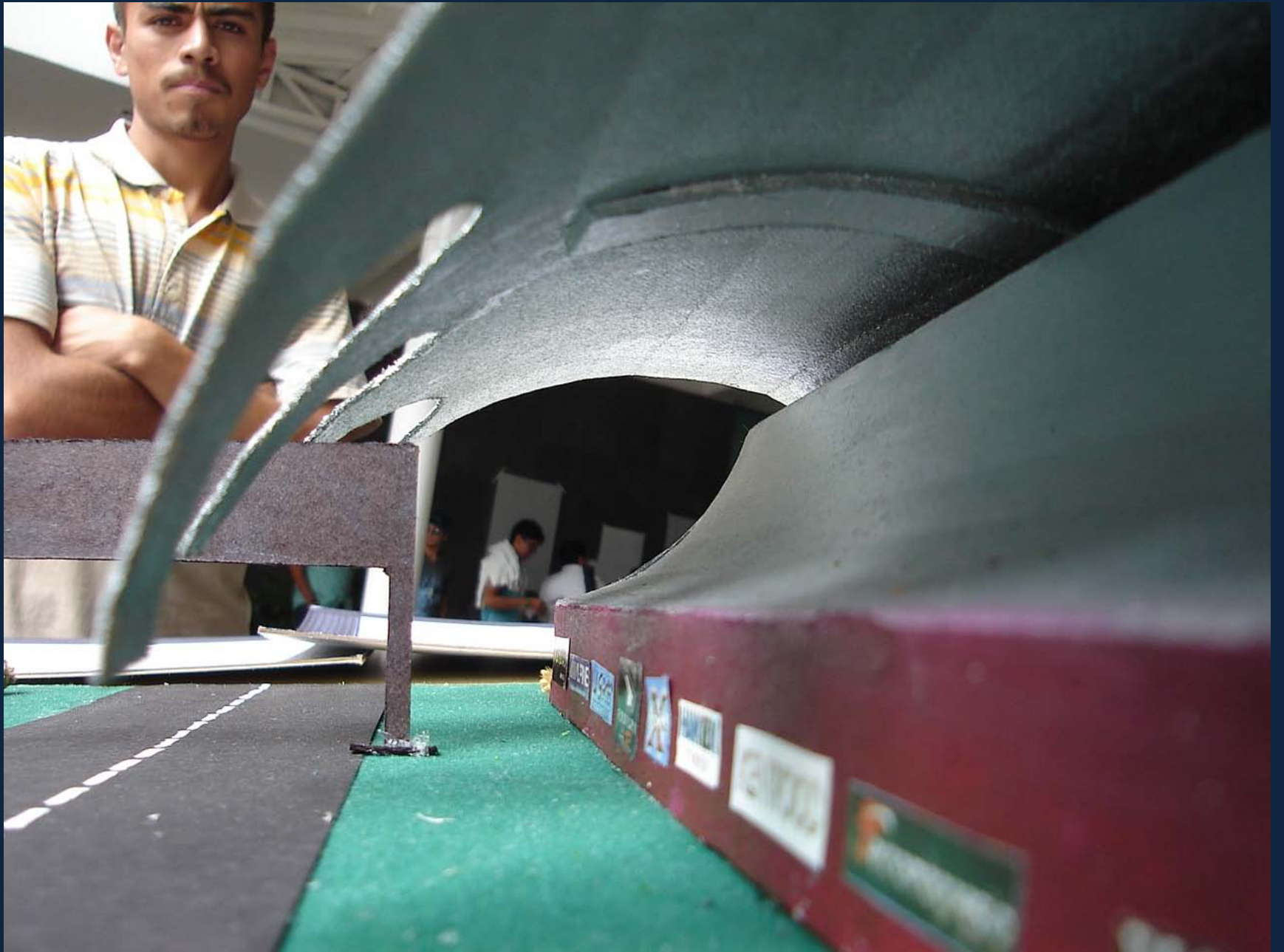

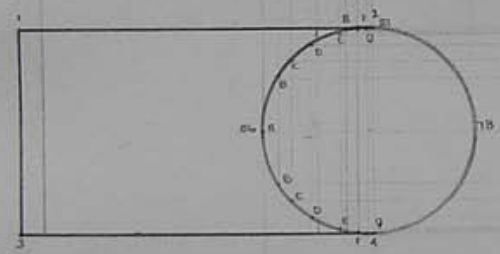
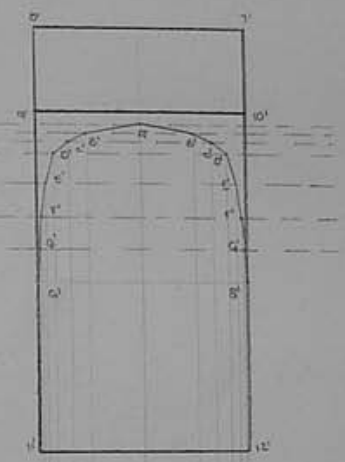
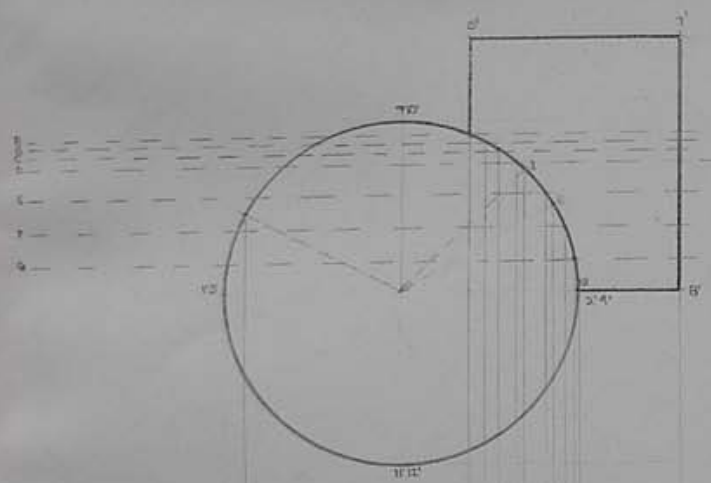

Rectification of a Groove

